

USER MANUAL

PowerWalker VFI 15000 MP 3/3
PowerWalker VFI 90000 MP 3/3 CB
PowerWalker VFI 90000 MP 3/3 CT
PowerWalker VFI 120000 MP 3/3 CB
PowerWalker VFI 120000 MP 3/3 CT
PowerWalker VFI 150000 MP 3/3 CB



UPS Series

Thank you for purchasing the N+X Modular Parallel Redundant UPS Series.

Safety information and operating instructions are included in this manual. To ensure correct use of the UPS, please read this manual thoroughly before operating it. Save this manual properly.

Safety and EMC Instructions

Please read carefully the following user manual and the safety instructions before installing the unit or using the unit!

1. Installation

- 1) Condensation may occur if the UPS is moved directly from a cold to a warm environment. The UPS must be absolutely dry before being installed. Please allow an acclimatization time of at least two hours.
- 2) Do not install the UPS near water or in damp environment.
- 3) Do not install the UPS where it would be exposed to direct sunlight or near heat.
- 4) Do not block ventilation openings in the UPS's housing.
- 5) Place cables in such a way that no one can step on or trip over them.
- 6) UPS has provided earthed terminals, in the final installed system configuration, equipotential earth bonding to the external UPS battery cabinets .
- 7) A readily accessible disconnect device should be incorporated in the building installation wiring and must be closed to the UPS.
- 8) This is permanently connected equipment, it must be installed by qualified maintenance personnel.
- 9) The floor's ability for handling the weight of the unit and battery pack should be taken into consideration before installation.

2. Operation

- 1) Earth connection is essential before connecting supply.
- 2) Even when disconnect UPS there is a hazardous voltage on the battery side, please don't touch live part, there may be electric shock risk.
- 3) In order to fully disconnect the UPS, first press Shut Down, then disconnect the mains lead.
- 4) Ensure that no liquid or other foreign objects can enter the UPS.
- 5) Operating the UPS must be performed by a service engineer from the manufacturer or from an agent authorized by the manufacturer.

3. Maintenance, servicing and faults

- 1) The UPS operates with hazardous voltages. Repairs may be carried out only by qualified maintenance personnel.
- 2) Risk of electric shock, this UPS receives power from more than one source-disconnection of the AC source and the DC source is required to de-energize this unit before servicing.
- 3) Before carrying out any kind of service and/or maintenance, please disconnect the batteries. Verify that no current is present and no hazardous voltage exists in the capacitor or BUS capacitor terminals.
- 4) Batteries must be replaced only by qualified personnel.
- 5) Caution - risk of electric shock. The battery circuit is not isolated from the input voltage. Hazardous voltages may occur between the battery terminals and the ground. Verify that no voltage is present before servicing!

6) Batteries have a high short-circuit current and pose a risk of shock. Take all precautionary measures specified below and any other measures necessary when working with batteries:

- remove all jewellery, wristwatches, rings and other metal objects.
- use only tools with insulated grips and handles.

7) When changing batteries, replace with the same quantity and the same type of batteries.

8) Do not attempt to dispose of batteries by burning them. It could cause explosion.

9) Do not open or destroy batteries. Effluent electrolyte can cause injury to the skin and eyes. It may be toxic.

10) Please replace the fuse only by a fuse of the same type and of the same amperage in order to avoid fire hazards.

11) Do not dismantle the UPS, except the qualified maintenance personnel.

4. Transport

Please transport the UPS only in the original packaging (to protect against shock and impact).

5. Storage

The UPS must be stockpiled in the room where it is ventilated and dry.

6. CE marking

The product has the CE marking in compliance with the following European directives:

LVD Directive (Safety)	2006/95/EEC
EMC Directive	2004/108/EEC



CAUTION

This product is designed for commercial and industrial applications. In a residential environment, the product may cause radio interference, in which the user may be required to take additional measures.







Contents

Chapter 1 Brief introduction.....	1
Chapter 2 Unpacking.....	2
Chapter 3 Exterior appearance.....	4
Chapter 4 Installation instructions.....	7
Chapter 5 Electrical installation.....	10
Chapter 6 Adding/Reducing/Replacing modules online.....	16
Chapter 7 Operation.....	18
Chapter 8 Menu Commands.....	22
Chapter 9 Maintenance.....	34
Chapter 10 Communication interface.....	36
Chapter 11 Troubleshooting.....	39
Chapter 12 Product specifications.....	41
Appendix 1 The reference table of LED indicators.....	44
Appendix 2 Battery configuration.....	45

Chapter 1 Brief Introduction

1.1 Description of commonly used symbols

Some or all of the following symbols may be used in this manual. It is advisable to familiarize yourself with them and understand their meaning:

Symbols and Indications	
Symbol	Description
	Attention
	Dangerous high voltage
	Alternating current(AC)
	Direct current(DC)
	Grounding Protection
	Recycle
	Do not dispose with sundries

Chapter 2 Unpacking

2.1 Unpacking inspection

Note: Check whether the UPS is damaged during the process of transportation or not. Should any damage be observed or parts be found missing, do not start the machine. Contact the forwarder and distributor immediately. Check the accessories supplied with the UPS and there should be:

- 1) One user manual;
- 2) Accessory includes screws ,cable tie and two keys.

- 1.Disassemble the top cover: cut off the packing tape by scissors and remove the top cover(Fig.2-1);
- 2.Disassemble the Side panels: adjust the plug tongue by Pliers and remove the Side panels(Fig.2-2);
- 3.Remove the foam and plastic bag around the unit(Fig.2-3);
- 4.Disassemble the screws which used to fix the mounting brackets by wrench, and adjust the height of adjustable feet(Fig.2-4);
- 5.Atleast 2 people is required to push the cabinet to the ground carefully by slope board(Fig.2-5);

Note: Make sure that the heights of the door and some other obstacles are appropriate.

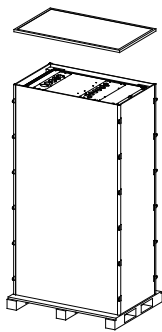

Fig. 2-1

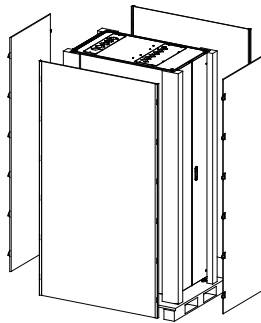

Fig. 2-2

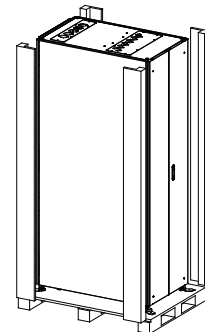

Fig. 2-3

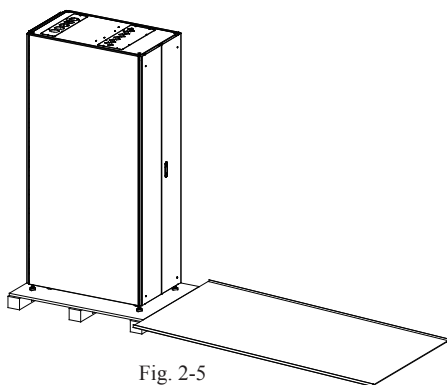

Fig. 2-5

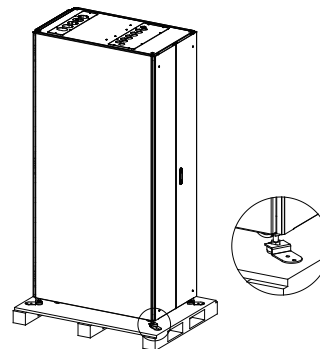

Fig. 2-4

2.2 Instruction for removing the module packaging

1. Cut off the packing strap and open the carton (see Fig. 2-6);
2. Lift the foam on the UPS module upward to remove them (see Fig.2-7);
3. Take out the UPS module (see Fig. 2-8).

Note: The UPS is heavy. It requires two people for transportation due to its weight.

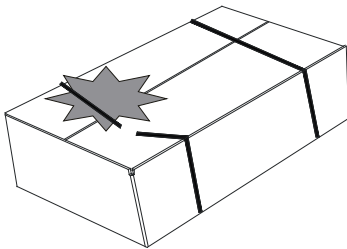

Fig. 2-6

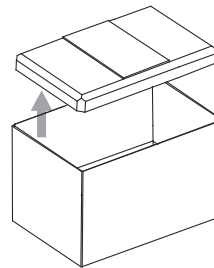

Fig. 2-7

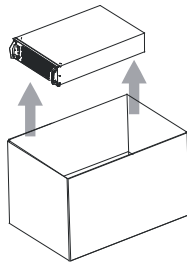

Fig. 2-8

Chapter 3 Exterior Appearance

3.1 Exterior figure of the UPS

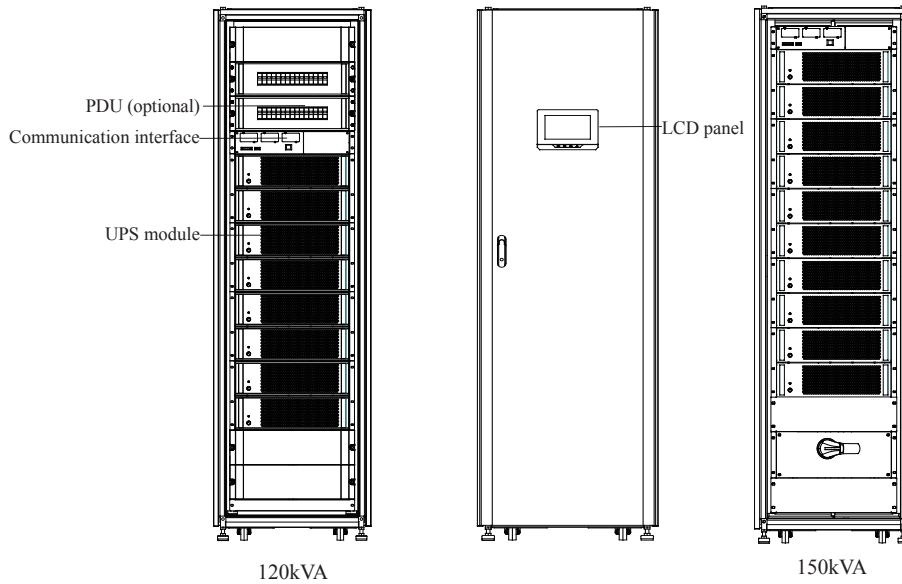

Fig. 3-1 Front view

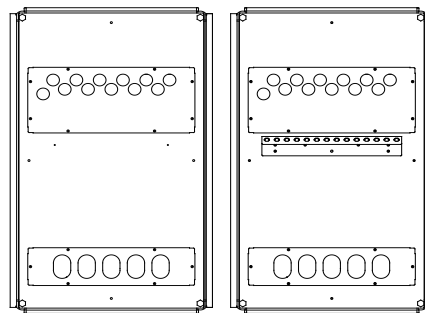

Fig. 3-2 Top view of cabinet with upper wire-outlet holes (the right figure containing of cable clamp)

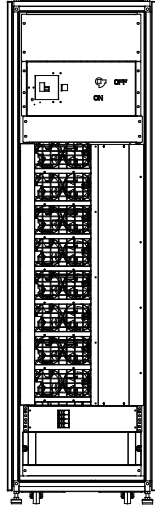

Fig. 3-3 120kVA rear view of cabinet with upper wire-outlet holes

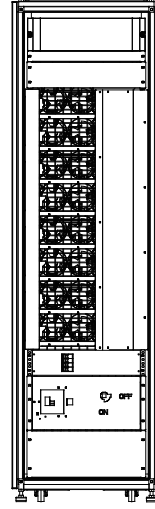

Fig. 3-4 120kVA rear view of cabinet with lower wire-outlet holes

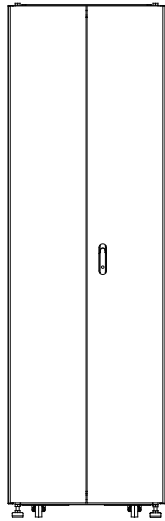

Fig. 3-5 150kVA rear view

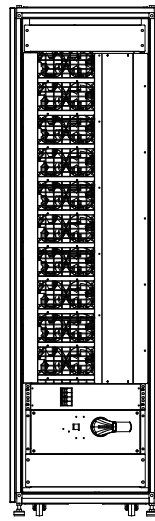

Fig. 3-6 150kVA rear view of cabinet with lower wire-outlet holes

3.2 Exterior figure of the module

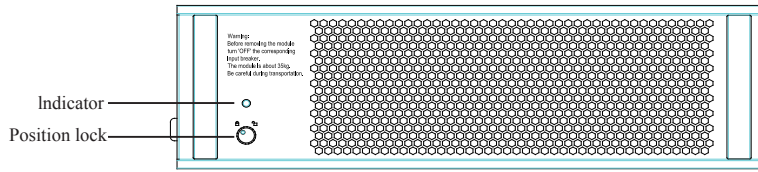

Fig. 3-7 Front view

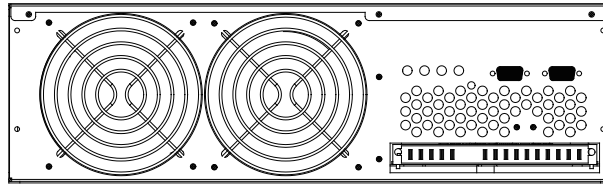

Fig. 3-8 Rear view

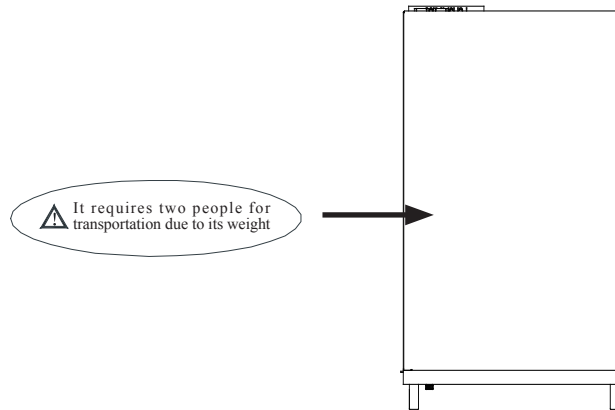

Fig. 3-9 Top view

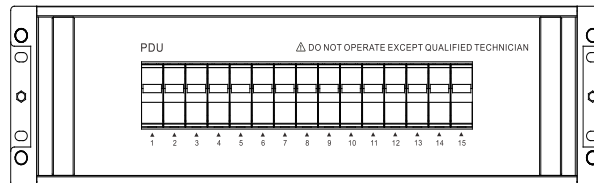

Fig.3-10 PDU front view

EN

Chapter 4 Installation Instructions

4.1 Installation notice

1. Install the UPS in a clean and stable environment that is free of vibration, dust, high humidity, flammable gas, flammable liquid or caustic substance.
2. The ambient temperature for the normal running UPS is required to be at 0°C - 40°C . If the UPS is operating in a more than 40°C environment, the maximum load capacity is required to be in accordance with the rating by 12% capacity decrease for every 5°C temperature rise. The maximum ambient temperature is required to be no more than 50°C .
3. It is recommended that the battery pack be used at the temperature of 15°C -25°C .
4. Altitude for normal UPS function should not exceed 1000m. Should UPS be intended for application above 1000m, progressive decrease of rated output should be applied as listed in the following:

(Nominal power capacity of the UPS = the maximum power capacity * Derating power)

Altitude (M)	1000	1500	2000	2500	3000	3500	4000	4500	5000
Derating Power	100%	95%	91%	86%	82%	78%	74%	70%	67%

5. The UPS utilizes fans for forced cooling, so considering ventilation for installation site is a must. Do not block the panels since there are ventilation grids in both the front and rear panels of the UPS.
6. The UPS adopts the positive-negative battery supply configuration. One battery pack consists of 32-40 batteries in series, which is divided into two parts by a neutral wire connecting to the middle of the pack. Therefore there are altogether three wires connected with the UPS terminal blocks including the positive and negative wires of the battery pack. The batteries between the positive terminal of the battery pack and the neutral wire are positive battery; while the batteries between the negative terminal and the neutral wire are negative battery (refer to the connection diagram for detailed information). You can choose the battery capacity and battery pack quantity according to your need. UPS capacity is varied with different battery configuration. The de-rating factor is shown in below table:

Battery Modules	40	38	36	34	32
Derating Power	100%	95%	90%	85%	80%

7. Wire Connection: the UPS is a three-phase input and three-phase output UPS and the input wire must be connected to the three-phase live wire and neutral wire. The output can be connected in different ways (Δ , Y or some other ways) according to the loads. Refer to the connection diagram for detailed information.
8. Wiring standard: the UPS adopts modular design and you may choose the quantity of the modules according to the load. It is recommended that the wiring be connected according to the maximum load for the safe use of the unit and the easy load expansion. The user can also perform the wiring according to the capacity of the modules. Refer to the table of wiring configuration in this manual.

4.2 Installation space

There must be at least 1000mm ($D1 \geq 1000\text{mm}$) of space in front of the front panel of the UPS and at least 800mm ($D2 \geq 800\text{mm}$) of space reserved behind the rear panel of the UPS for maintenance and air-cooling.

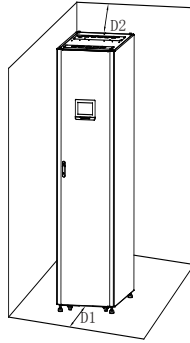

Fig. 4-1

4.3 Installation process

1. Disassemble the screws which used to fix the mounting brackets by socket or wrench, and adjust the height of adjustable feet;
2. Push the cabinet to the predetermined location and adjust the height of adjustable feet by wrench to set the casters in vacant position.
3. Fix the adjustable feet with the mounting brackets (by M8 anchor bolts, Fig. 4-2)

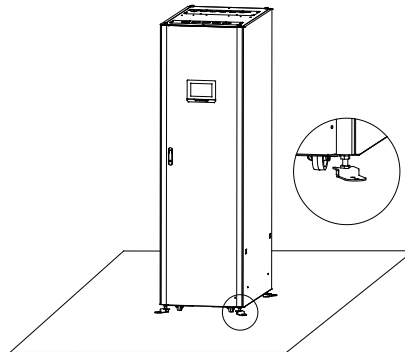





Fig. 4-2

4. Remove the packaging of the UPS module and check the position lock located on the front panel of the module. In normal condition, the white dot on the position lock should be at the position of “” (Fig. 4-3); if the white dot is at the position of “”, please turn it to the “” position.

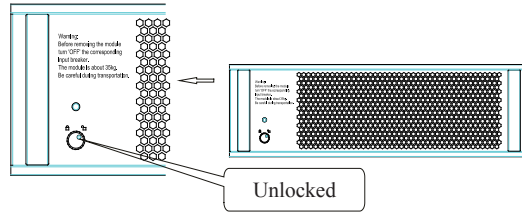

Fig. 4-3

5. Slide the UPS module into a bay of the frame until it is in the cabinet completely.
Note: the module is heavy. It requires two people for installation due to its weight.
 6. Set the position lock on the front panel of the module to the “” position (Fig.4-4);
 7. Repeat the above 4-6 steps to install all of the UPS modules into the cabinet in sequence. (Fig.4-5);
 8. Install the PDU module (optional): Remove the plastic blind plate and adjust the position of caged nuts, fix the PDU to predetermined position with the M6 hex screws;
 9. PDU wiring (optional): Connect the cabal on PDU to the corresponding output copper bus bars of UPS.
- Note: The height of PDU is 3U,the distance between the 2 mounting hole is 2U.

EN

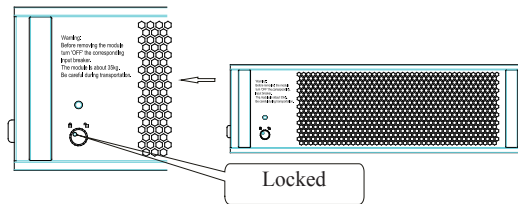

Fig. 4-4

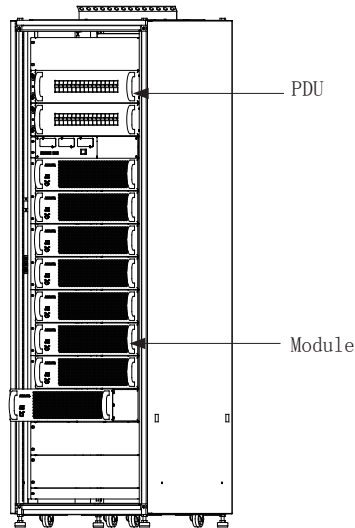

Fig. 4-5

Chapter 5 Electrical Installation

The electrical installation of the UPS must be performed according to the electrical code and the UPS installation specifications by a qualified engineer that has passed the training. Any other personnel with no qualification are forbidden to perform the installation. Only basic installation instructions are included in this manual and please refer to the installation specifications for detailed information.

5.1 Requirements of wiring cables

The UPS provides four options on its cabinet capacity (maximum UPS modules that can be contained in the cabinet): 60kVA (maximum four UPS modules), 90kVA (maximum six UPS modules), 120kVA (maximum eight UPS modules) and 150kVA (maximum ten UPS modules). And overload and line voltage should also be taken into consideration for wire diameter selection on the basis of the cabinet capacity options. It is generally recommended that the user choose the wire diameter according to the maximum capacity of the UPS cabinet, which can ensure that there is no need to change the wire diameter when expanding the capacity of the UPS.

If the quantity of the UPS modules installed is less than the capacity of the UPS cabinet, the user can also choose the wire diameter according to the actual needs. The wire diameter may vary with the quantity of the UPS modules installed. Please refer to the table below for module quantity and corresponding wire diameter.

Module	Cable Cross Section									
	UPS Input				UPS Output				Battery Cable	
	L		N		L		N		UL	GB
UL	GB	UL	GB	UL	GB	UL	GB			
1	12AWG	6mm ²	6AWG	16mm ²	12AWG	6mm ²	6AWG	16mm ²	12AWG	6mm ²
2	6AWG	16mm ²	6AWG*2	16mm ² *2	6AWG	16mm ²	6AWG*2	16mm ² *2	6AWG	16mm ²
3	4AWG	25mm ²	4AWG*2	25mm ² *2	4AWG	25mm ²	4AWG*2	25mm ² *2	4AWG	25mm ²
4	6AWG*2	16mm ² *2	2AWG*2	35mm ² *2	6AWG*2	16mm ² *2	2AWG*2	35mm ² *2	6AWG*2	16mm ² *2
5	4AWG*2	25mm ² *2	4AWG*3	25mm ² *3	4AWG*2	25mm ² *2	4AWG*3	25mm ² *3	4AWG*2	25mm ² *2
6	4AWG*2	25mm ² *2	2AWG*3	35mm ² *3	4AWG*2	25mm ² *2	2AWG*3	35mm ² *3	4AWG*2	25mm ² *2
7	4AWG*2	25mm ² *2	2AWG*3	35mm ² *3	4AWG*2	25mm ² *2	2AWG*3	35mm ² *3	4AWG*2	25mm ² *2
8	2AWG*2	35mm ² *2	2AWG*3	35mm ² *3	2AWG*3	35mm ² *2	2AWG*3	35mm ² *3	2AWG*3	35mm ² *2
9	2AWG*3	35mm ² *3	4/0AWG*2	95mm ² *2	2AWG*3	35mm ² *3	4/0AWG*2	95mm ² *2	2AWG*3	35mm ² *3
10	1/0AWG*2	50mm ² *2	4/0AWG*2	95mm ² *2	1/0AWG*2	50mm ² *2	4/0AWG*2	95mm ² *2	1/0AWG*2	50mm ² *2

Note:

1. The conductor cross sections above apply for theoretical maximum currents in consideration of protective devices.
2. *n represents the number of the wire, which indicates that n same AWG wires are needed. For example, “2AWG*3” indicates that three 2 AWG wires are needed.
3. The diameter of the earth wire needs to be the same as the N wire.

5.2 Requirements of protective devices

The voltage and current should be taken into consideration when selecting NFB. And it is recommended to select it according to the real capacity of the UPS (the modules installed) to ensure effective protection. Please refer to the table below for UPS module and corresponding NFB requirements.

EN

UPS Module	UPS Input NFB	UPS Output NFB	Battery NFB
	Voltage/Current	Voltage/Current	Voltage/Current
1	3φ 40A/ 250VAC	3φ 40A/ 250VAC	3φ 40A/ 500VDC
2	3φ 80A/ 250VAC	3φ 80A/ 250VAC	3φ 80A/ 500VDC
3	3φ 120A/ 250VAC	3φ 120A/ 250VAC	3φ 120A/ 500VDC
4	3φ 160A/ 250VAC	3φ 160A/ 250VAC	3φ 160A/ 500VDC
5	3φ 200A/ 250VAC	3φ 200A/ 250VAC	3φ 200A/ 500VDC
6	3φ 240A/ 250VAC	3φ 240A/ 250VAC	3φ 240A/ 500VDC
7	3φ 280A/ 250VAC	3φ 280A/ 250VAC	3φ 280A/ 500VDC
8	3φ 320A/ 250VAC	3φ 320A/ 250VAC	3φ 320A/ 500VDC
9	3φ 360A/ 250VAC	3φ 360A/ 250VAC	3φ 360A/ 500VDC
10	3φ 400A/ 250VAC	3φ 400A/ 250VAC	3φ 400A/ 500VDC

Note: It is recommended to choose three-pole NFBs (linked breaker) for the input and output of the UPS and a three-pole NFB (linked breaker) for the battery. Refer to the Section 5.3 and Section 5.4 in this manual for detailed information.

5.3 The wiring diagram

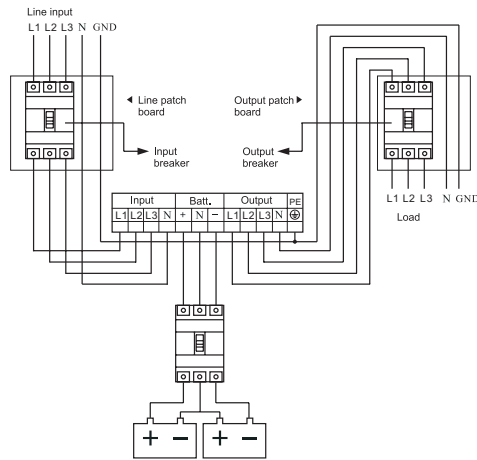

Fig. 5-1 The wiring diagram

Remark:

1. The input N wire of the UPS must be connected correctly.
2. One battery pack of the UPS consists of 32-40 batteries in series, 40PCS configuration is illustrated as an example in Fig. 5-2. which is divided into two parts by a neutral wire connecting to the middle of the pack (where the No. 20 and No. 21 batteries are connected). Therefore there are altogether three wires connected with the UPS terminal blocks including the positive and negative wires of the battery pack. The battery cables should connect to a DC breaker firstly and then it can be connected to the terminal block of the UPS. Please refer to the following wire connection diagram for detailed information.

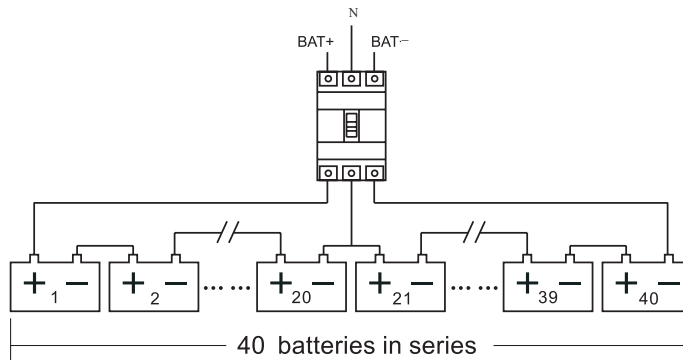

Fig. 5-2 Sketch map of Battery connected

Note: The three wires of the battery pack should be connected to the UPS correctly according to the marks, otherwise, it may cause hazards of battery short circuit. So make sure to double-check them before connection. It is required to use DC breakers complying with the safety requirements due to a multiple quantity of batteries in series.

5.4 Installation instructions

1. Wiring Location

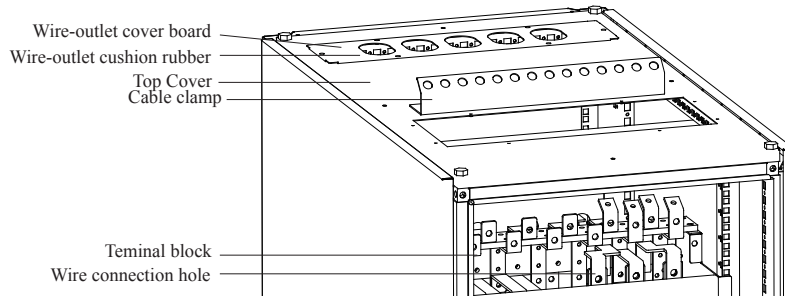

Fig. 5-3 Wiring location of cabinet with upper wire-outlet holes
(without the wire-outlet cover board besides the cable clamp)

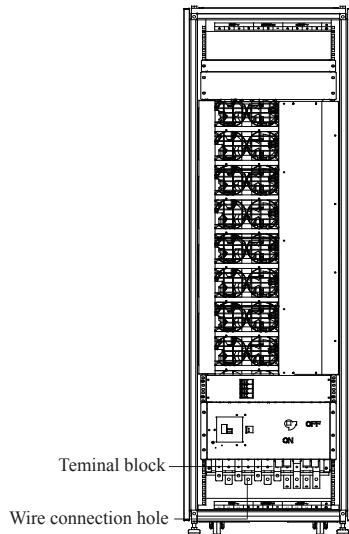

Fig. 5-4 Wiring location cabinet with lower wire-outlet holes

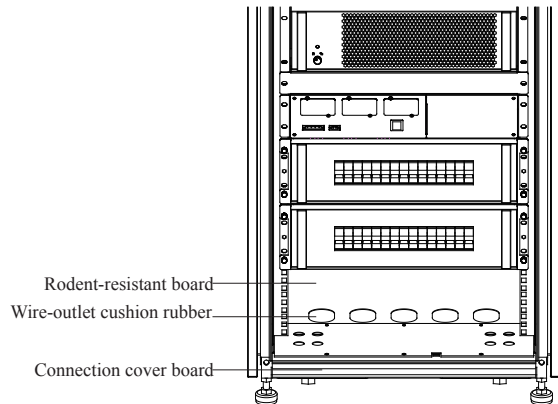

Fig. 5-5 Wiring location of reserved bottom power distribution panel

2. Electrical Installation Illustration

Wire connection cabinet with upper wire outlet holes

- 1) Remove the front terminal block cover (see Fig. 5-6).
- 2) Connect the UPS input, output and battery wires to the corresponding copper bars frontally through the wire cushion rubbers on the top cover according to the marks (the copper bar marks are shown as Fig. 5-7).
- 3) Reinstall the terminal block cover and secure it with screws.
- 4) Fix the wires to the cable clamp with cable ties.

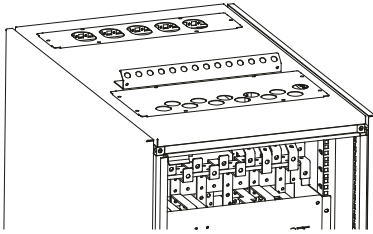

Fig. 5-6

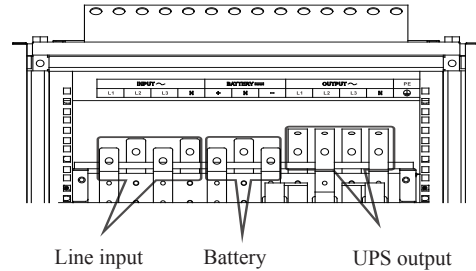

Fig. 5-7

Wire connection cabinet with lower wire outlet holes

- 1) Remove the front terminal block cover and bottom connection cover board (see Fig. 5-8).
- 2) Connect the UPS input, output and battery wires to the corresponding copper bars frontally through the wire cushion rubbers on the rodent-resistant board according to the marks (the copper bar marks are shown as Fig. 5-9).
- 3) Reinstall the front terminal block cover and bottom connection cover board and secure them with screws.

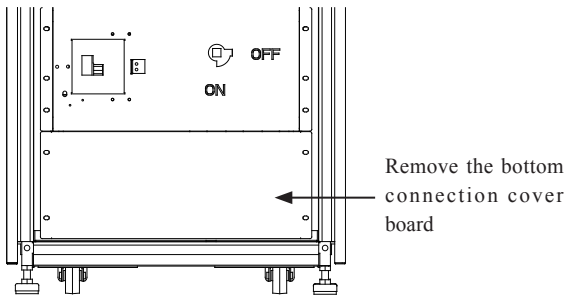

Fig. 5-8

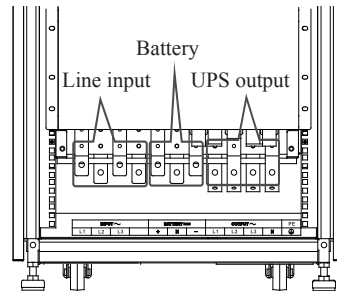

Fig. 5-9

Note:

Wire connection of 150kVA cabinet with lower wire outlet holes

- 1) Remove the rear terminal block cover and bottom connection cover board.
- 2) Connect the line input and battery wires to the corresponding copper bars through the wire cushion rubbers on the rodent-resistant board according to the marks (the copper bar marks are shown as Fig. 5-10).
- 3) Remove the front terminal block cover, connect the UPS output wires to the corresponding copper bars according to the marks (the copper bar marks are shown as Fig. 5-11). Prior to the wire connection, make sure earth connection has been done.
- 4) Reinstall the terminal block covers and bottom connection cover board and secure them with screws.

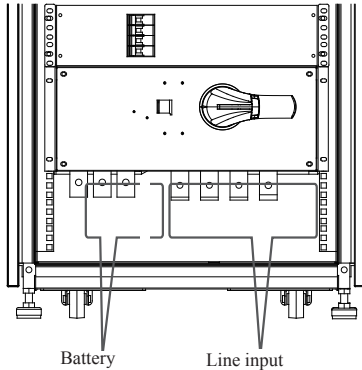

Fig. 5-10

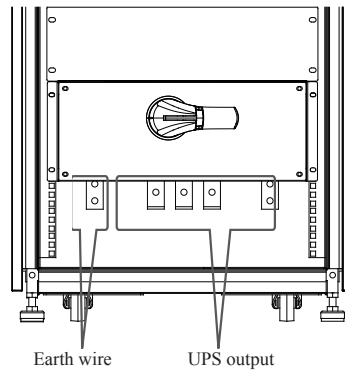

Fig. 5-11

5.5 Backfeed Protection

On customers side an additional external isolation device (magnetic contactor, MC or minimum voltage tripping device) must be provided as shown in Fig 5-12. The isolation device must be able to carry the UPS input current.

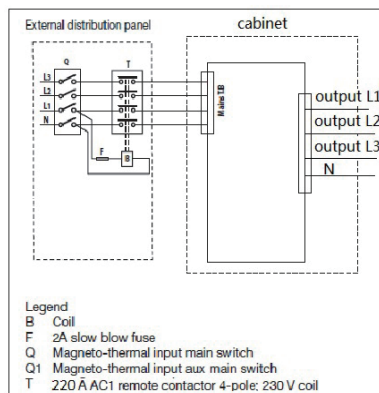

Fig. 5-12

After the device is installed, you must add a warning label with the following wording or the equivalent on the external AC contactor.

RISK OF VOLTAGE BACKFEED. Isolate the UPS before operating on this circuit, then check for hazardous voltage between all terminals.

Chapter 6 Adding/Reducing/Replacing Modules Online

N+X is the most reliable power supply configuration at present. N represents the minimum number of modules of the UPS that the total load needs; X represents the number of the redundant modules of the UPS, i.e. the number of the fault modules that the system can handle simultaneously. The bigger X is, the higher the system reliability is. The UPS can be installed up to 10 modules in its cabinet and the N+X parallel redundancy system can be configured as 1+9 or 9+1 etc multiple different modes. The UPS modules can be added, reduced and changed online and the quantity of the N and X of the N+X parallel redundancy system can be changed according to requirement at any time. When the modules fail, if only the quantity of the fault modules is less than or equal to X, the fault UPS modules can be changed online without affecting the UPS running.

6.1 Options supplied by the N+X parallel redundancy system

The UPS can be installed from 1 up to 10 UPS modules in its cabinet and the user can choose the N+X parallel redundancy solution easily. Suppose the load is 25kVA and the optional solution is listed in the following table:

N+X	Permitted Maximum Power		Permitted Quantity of the Fault UPS Modules
	Apparent Power (kVA)	Active Power (kW)	
2+0	30	27	0
2+1	30	27	1
2+2	30	27	2
2+3	30	27	3
2+4	30	27	4
2+5	30	27	5
2+6	30	27	6
2+7	30	27	7
2+8	30	27	8

Note:

1. The “Permitted Maximum Power” does not mean that the UPS will be overloaded if this power value is exceeded. For example, when selecting the 2+2 configuration, the rated UPS apparent power is 60kVA and active power is 54kW, therefore, if load exceeds the permitted maximum power 27kW (permitted maximum power), the UPS will not be overloaded and only the N+X (X=2) structure will be changed.
2. The “permitted maximum power” indicates the three-phase power, so the permitted maximum power of single-phase needs to be divided by three.

6.2 Adding, reducing and changing the UPS modules online

The UPS module is hot swappable, and when performing adding, reducing or changing the UPS modules online, the operating instructions must be strictly followed.

1. Removing the UPS Module Online

- 1) Set the position lock located on the front panel of the module to “” (see Fig. 6-1) and Set the input breaker of the UPS module rear to OFF position (see Fig. 6-2).
- 2) Two people each hold the handles located on the front panel of the UPS module with one of their hands and support the bottom of the module with the other hand respectively and they both use their strength together to draw the module outward smoothly and slowly until it is out, and then support it together and put it on the ground or some other temporary supports gently.

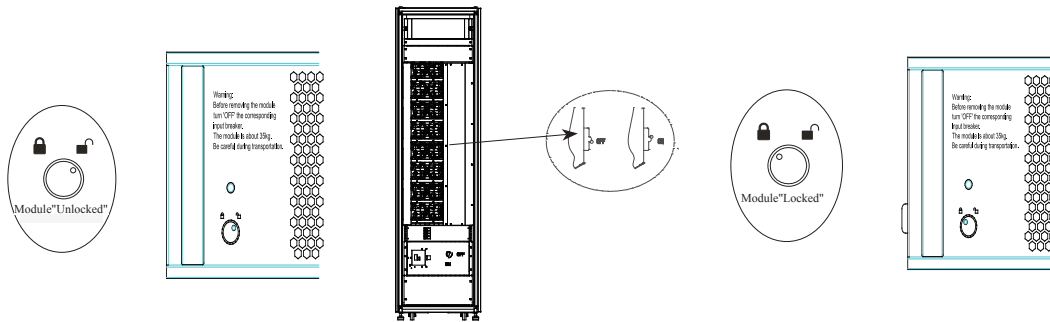



Fig. 6-1

Fig. 6-2

Fig. 6-3

2. Adding the UPS Module Online

- 1) Remove the cover plate located in the position where the module will be installed.
- 2) Two people each hold the handles located on the front panel of the UPS module with one of their hands and support the bottom of the module with the other hand respectively and slide the module into the bay of the frame together.
- 3) Set the position lock located on the front panel of the module to “” (see Fig. 6-3).
- 4) The input breaker of the module rear to ON position (see Fig. 6-2).
- 5) If you add a UPS module in line mode, the new module will work in the parallel system automatically; while if you add a UPS module in battery mode, the new module will not build a power supply nor work in the parallel system until you have completed the above four steps and turn on/off the cold starting switch repeatedly.

Chapter 7 Operation

7.1 LCD Interface

LCD screen is located in the front of the cabinet. Touch screen allows users to operate the UPS easily. The LCD display is shown as the following two sections: UPS status bar and data display space. The UPS status bar provides the basic UPS status information for users by different colors; while the data display space provides the detailed UPS information for users through the LCD screen.

EN

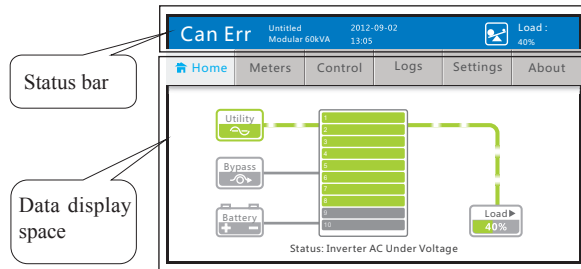

Fig. 7-1

7.1.1 Status bar

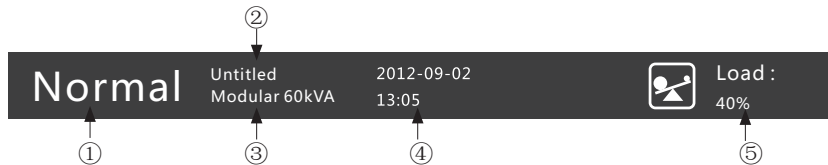

Fig. 7-2

- ① System status:
Display the current machine status.
- ② Machine name:
It is defined by users. If the user has several cabinets, they can be distinguished by setting names.
- ③ Machine model and capacity:
Model: Modular xxKVA; capacity is automatically displayed depending on the number of modules
- ④ System time:
Display the system time in the Communication service board (CSB)
- ⑤ Meters information:
Display information on the following three Meters: output voltage and frequency, load and battery capacity. Under normal circumstances, only the output voltage and frequency as well as load are displayed, with a scrolling interval of 3s. If the system turns to the battery mode and the battery capacity is low, only the battery capacity is displayed without scrolling and displaying other information.

Color of status bar:

Color	Description
Blue	The modes that the system is in: Shutdown, Standby, Normal, Converter, Battery (sufficient battery capacity) and Battery Test(sufficient battery capacity)
Orange	The modes that the system is in: Bypass, Battery (low battery capacity) and Battery Test(low battery capacity)
Red	System in Fault mode; the status bar is flashing between red and light blue. Click the exclamation mark to enter the current event interface and view the status information.

EN

7.2 Startup

Note: check whether the input, output and the battery cables are connected correctly before turning on the UPS, if not, refer to the instruction and reconnect the cables. Do not perform the following operation until you make sure that the cables are connected properly.

1. Turning on the UPS in normal condition (the utility power is normal and the battery is dispensable)

1) Push the input breaker located on the back of the UPS to ON position .

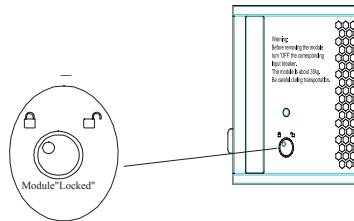



Fig. 7-3

2) Check the position locks located on the front panel of the installed UPS modules. Make sure that all of them are in the “” position (see Fig. 7-3).

3) Set the battery breaker to ON position (external breaker).

4) Set the line input breaker (external) to ON position.

5) If the system is started up with no utility power, the “Cold Starting Switch” (Fig. 7-4) on the communication interface needs repeatedly powering on and off. After the system is connected by cold start for about 1min, it automatically enters the Home.

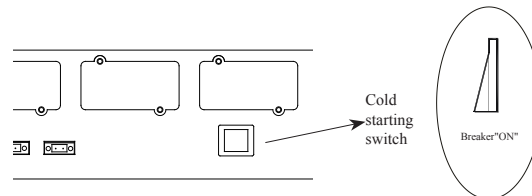
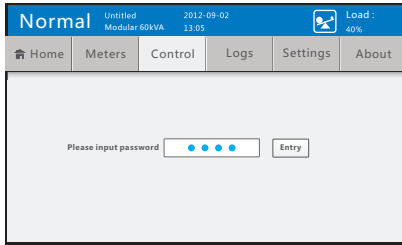

Fig. 7-4

- ① Enter the Home and click the “Control” button to enter the login interface. Type the correct control password or user password, click the ENTER key and then click the “Enter” button to enter the system control interface;



If the control password is set to the enabled status, the password is required to enter the system control interface. The default control password and user password are 1111 and 1234 respectively.

If the control password is set to the disabled status, click the “Control” button on the Home menu bar to directly enter the system control interface.

- ② On the system control interface, click the “Start” button to pop up a confirmation prompt box. After clicking OK, if the system meets the startup conditions, the startup is successful and the startup button turns to green.

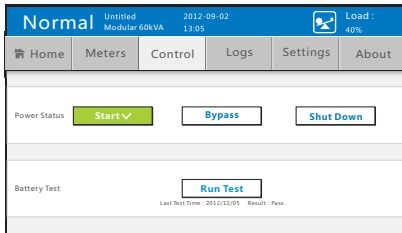

If the system fails to meet the startup conditions, the prompt box will be popped up to show message on operation prohibited as follows:

Button	Message on operation prohibited
Startup	1. No UPM or UPM has no power,cannot go Online!
	2. EPO is active,cannot go Online!
	3. UPM is unlock or switchgear is open,cannot go Online!
	4. Maintenance cover is open,cannot go Online!

7.3 Turning off the UPS

- ① Enter the Home and click the “Control” button to enter the login interface. Type the correct control password or user password, click the ENTER key and then click the “Enter” button to enter the system control interface;

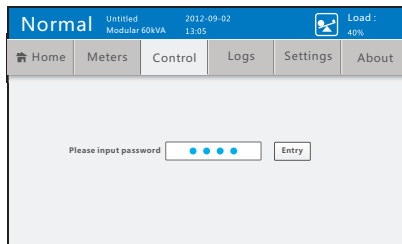

If the control password is set to the enabled status, the password is required to enter the system control interface. The default control password and user password are 1111 and 1234 respectively.

If the control password is set to the disabled status, click the “Control” button on the Home menu bar to directly enter the system control interface.

② Select “Bypass”, and then the bypass supplies power to the load. The “Bypass” button turns to orange.

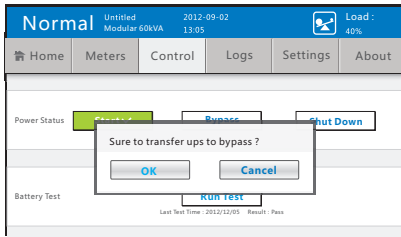

If the system fails to meet the startup conditions, the prompt box will be popped up to show the message on operation prohibited as follows:

Button	Message on operation prohibited
Shutdown to bypass	1. Bypass is forbidden on Converter Mode!
	2. Bypass is abnormal, cannot go to Bypass!

③ Select “Shut Down”, and “UPS is already shutdown” is displayed after 10s. If the system is in the shutdown status and click the Shutdown button, the prompt box will show that “UPS is not running!”.

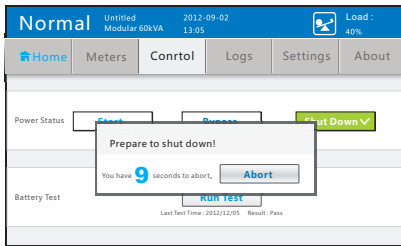

EN

Chapter 8 Menu Commands

8.1 Function description on menu commands

Menu list	Description
Home	Display the menu bar and system status simulation diagram.
Meters	Used for viewing the meters types: System Meters, Module Meters and Battery Meters.
Control	Provides power control command. Control the Startup, Shut Down of UPS and Battery Test.
Logs	View the current and historical UPS alarm fault information through “Logs”, and the historical logs can be cleared.
Setting	Used for UPS setting and maintenance.
About	Used for users and maintenance personnel to view the software version numbers of all modules and system information; and also provide the maintenance time remainders.

Submenu item		Function description	
Meters	System Meters	Display the three-phase input/bypass/output voltage and frequency meters.	
	UPM Meters	Display the current status of each module. The status corresponding to module color is in accordance with that shown in the Home.	
	Battery Meters	Display the status, voltage, current, backup time and capacity of positive and negative batteries.	
Control	System Control	Switch the operation status of UPS system and perform the battery test, such as Startup, Shut Down and Bypass, Shut Down and Battery Test.	
Logs	Active Event	Display the information on Active Event, Including Event ID, Name and Type.	
	System Logs	Display the information on System Logs, Including Time, Event ID, Name, Source, Type; Service Password is required to enter it.	
	Clear Logs	Entering service password can clear all the event logs.	
Setting	Configuration	Language Selection	Set the language type: English.
		Machine Name	The name is set not more than 14 characters. The keyboard is a system built-in text keyboard.
		System tTme	Set the date and time displayed on LCD panel of UPS system.
		Battery Test	Obtain the battery information via the battery test.
		Screensaver Time	Set the screensaver time. When it is out of the set range with no actions, turn off the backlight and enter the screensaver status.
		Light Test	Undergo the light test.
		LCD backlight	Set the brightness of LCD backlight.
		Control Password	Set the control password to disable or enable status and change the password.
		Configuration Password	Set the configuration password to disable or enable status and change the password.
		Service Phone	Set the customer service telephone number, max. 13 numbers.

Submenu item		Function description	
Setting	Service	Battery Setting	Battery configuration: set the battery model, group number, number, temperature compensation, battery current detection. These can be undergone only under the Standby Mode or Bypass Mode. Battery charge: By opening or closing chargers for 10 modules, control the charging current. Battery discharge: set the low voltage alarm value when the battery is discharging (Voltage of a single battery: 10.5~11.3V). It can be undergone only under the Standby Mode or Bypass Mode.
		Output Setting	Set the output voltage and output frequency of the system. 1. They can be set only under the Standby Mode or Bypass Mode; 2. If the system is set to the Converter Mode, do not set the frequency.
		Bypass Setting	Displays the current or post-setting upper and low limit voltages for bypass. This setting can be undergone only under Standby Mode or Bypass Mode.
		System Mode	Set the System Mode. The Normal Mode and Converter Mode are optional.
		Minislot Baudrate	CSB panel has three slots for smart card. The baud rates for these three slots can be set.
		Service Teminder	UPS provides regular maintenance reminder service via the automatic timing function since the installation and use date, including over warranty reminder and maintenance reminder.
		Installation Time	Set the installation time in the format of YYYY-MM-DD.
		Resetting Password	Reset the control password, configuration password and unlock the XCP burning. After resetting, the control password and configuration password are default to be disabled. The XCP burning will be re-locked after unlocked for 30 min.
		Exporting Logs	Export the saved historical logs to USB device, which can save up to 10,000 logs.
		Other Messages	Displays BUS voltage and battery temperature.
		About	User Information
Version Information	Displays the module version.		
Service Information	Displays the dates for over-warranty information, maintenance reminder and installation.		

Note: The following menu screen and settings are for reference only. They are subject to change without notice.

8.2 Home

The Home contains two sections: menu bar and system status simulation diagram.

The simulation diagram is divided into three parts as follows: system power supply status, UPS module status and load status.

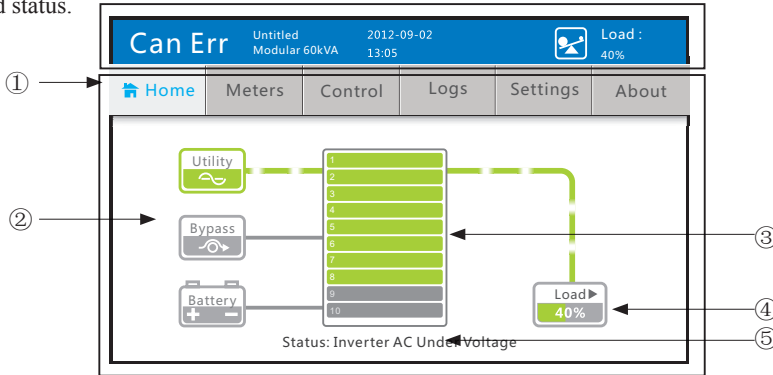
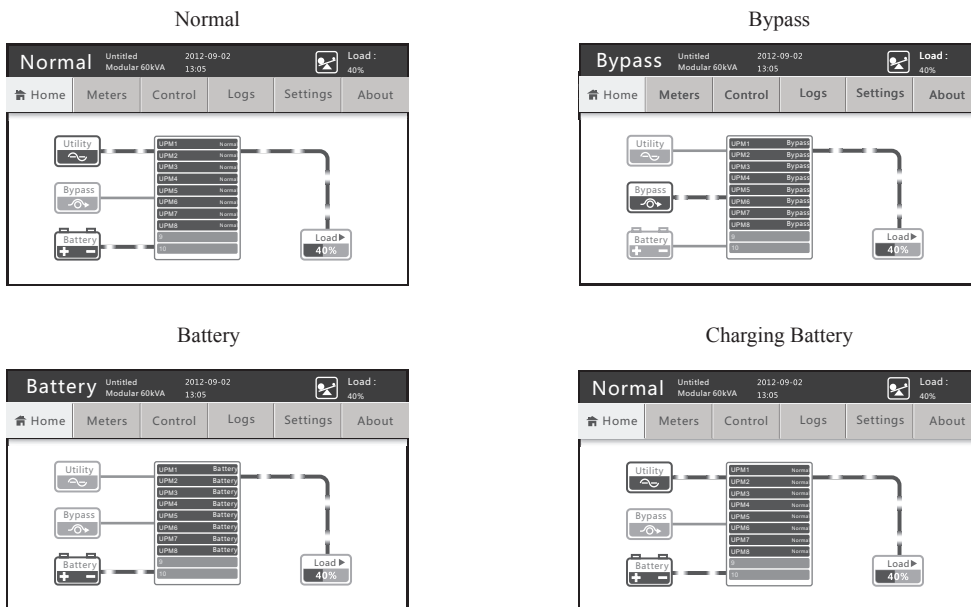

Fig. 7-5

① Menu bar

Single clicking the menu bar allows to enter the corresponding interfaces to view, control and set the system status. The menu bar consists of Home, Parameter, Control, Logs, Setting and About.

② System power supply status



Icon	Description
Utility power	<ol style="list-style-type: none"> When the utility power is normal, the icon lights; when the utility power is abnormal, the icon darks. When the utility power supplies power for the system, the flow diagram for utility power circuit is displayed. By clicking this icon, it can turn to system parameter interface to view the input information.
Bypass	<ol style="list-style-type: none"> When the bypass is normal, the icon lights; when the bypass is abnormal, the icon darks. When the system is in bypass status, the flow diagram for bypass circuit is displayed; otherwise, the flow diagram for bypass power supply will be disappeared. By clicking this icon, it can turn to system parameter interface to view the bypass information.
Battery	<ol style="list-style-type: none"> When the batteries are connected, the icon lights; and when the batteries are unconnected, the icon darks. When the batteries supply power for the system, the flow diagram for battery circuit is displayed with the current flowing: batteries -> UPS. When the system is charging the batteries, the flow diagram for battery circuit is displayed with the current flowing: UPS -> batteries. By clicking this icon, it can turn to battery parameter interface to view the battery information.

③ UPS module status

The statuses for each UPS module can be displayed, with a maximum of 10 module icons shown. When the module is in different status, the color of icon will be changed with text explanation. The meanings for the module icon colors are specified as follows:

Color	Meaning	Remarks
Grey	Not insert module or the module status being unknown	Click any position of the UPS, it can turn to the module parameter interface, in convenience of viewing each module status.
Light blue	Module being in Standby, Shut Down and Other Modes	
Green	Module being in Utility, Converter, Battery, Battery Test and Other Modes	
Orange	Module being in Bypass Mode	
Red	Module being in Fault Mode	

④ Load status

When the UPS is loading, its output circuit will be displayed as a flow diagram; otherwise, the output circuit will be grey. By single clicking the load icon, it can turn to the system output parameter interface to view the detail load information. The percentage of the total load for system is shown by numbers and scale bar.

⑤ System alarm

At the bottom of Home, the alarm information for system will be displayed in real time. When the system has several alarms, the alarm information will be scrolled.

8.3 Parameter

① Click the “Meters” icon on the Home menu to enter the parameter interface.

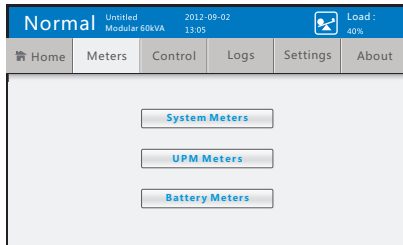

② Click the “System Meters” to enter the system meters interface. If this interface is accessed by clicking the “Normal” or “Bypass” icon on the Home, it will directly return to the Home when exiting.

	Voltage(V)	Frequency(Hz)
Input	A 218.5	47.5
	B 218.5	47.5
	C 218.5	47.5
Bypass	A 218.5	47.5
	B 218.5	47.5
	C 218.5	47.5
Output	A 220.2	50.2
	B 220.2	50.2
	C 220.2	50.2

③ Click the “UPM Meters” to enter the module meters interface. If this interface is accessed by clicking the UPS icon on the Home, it will directly return to the icon when exiting.

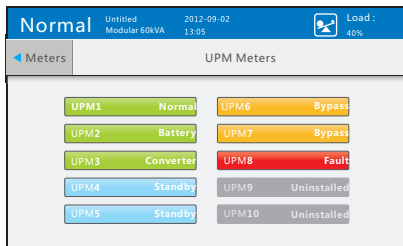

④ Click the “Battery Meters” to enter the battery meters interface. If this interface is accessed by clicking the “battery” icon on the Home, it will directly return to the Home when exiting.

a. battery current and backup time disable

	Status	Voltage(V)	Capability(%)
Positive Battery	Disconnected	220.2	90%
Negative Battery	Disconnected	220.2	90%

b. battery current enable , backup time disable

	Status	Voltage(V)	Current(A)	Capability(%)
Positive Battery	Disconnected	220.2	45.0	90%
Negative Battery	Disconnected	220.2	45.0	90%

EN

c. battery current disable, backup time enable

Normal				
Untitled Modular 60kVA		2012-09-02 13:05	Load: 40%	
Battery Meters				
	Status	Voltage(V)	Capability(%)	Backup(min)
Positive Battery	Disconnected	220.2	90%	35
Negative Battery	Disconnected	220.2	90%	35

d. battery current and backup time enable

Normal					
Untitled Modular 60kVA		2012-09-02 13:05	Load: 40%		
Battery Meters					
	Status	Voltage(V)	Current(A)	Capability(%)	Backup(min)
Positive Battery	Disconnected	220.2	45.0	90%	35
Negative Battery	Disconnected	220.2	45.0	90%	35

EN

8.4 Control

① Click the “Control” icon on the Home menu to enter the login interface. The control password or user password or service password is required to enter the system control interface. The default control password and user password are 1111 and 1234 respectively.

Normal					
Untitled Modular 60kVA		2012-09-02 13:05	Load: 40%		
Home	Meters	Control	Logs	Settings	About
Please input password <input type="password"/> <input type="button" value="Entry"/>					

The “Control password” can be replaced by the “User password” or “Service password”.

The “User password” can be replaced by the “Service password”.

② If the password is correct, enter the “System Control” interface.

Normal					
Untitled Modular 60kVA		2012-09-02 13:05	Load: 40%		
Home	Meters	Control	Logs	Settings	About
Power Status <input type="button" value="Start"/> <input type="button" value="Bypass"/> <input type="button" value="Shut Down"/>					
Battery Test <input type="button" value="Run Test"/>					
Last Test Time: 2012/12/05 Result: Pass					

The “System Control” interface has these buttons of “Startup, Shutdown to bypass, shutdown and Run Test”
The colors for the lighted buttons of Startup, Shutdown to bypass and shutdown are respectively green, orange and red. See chapters 7.2 & 7.3 for details.

③ Click “Battery Test” to pop up a confirmation prompt box.

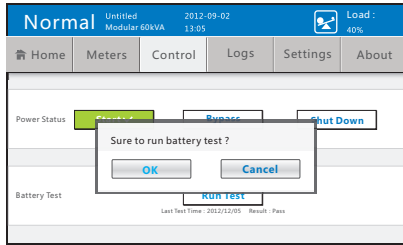

④ If the system is not under the Normal Mode or Converter Mode, the prompt box will be popped up to show “Please carry out battery test in Normal or Converter mode!” Make sure if the UPS is on the Normal mode or Converter Mode at the status bar; Otherwise enter the control interface and do test after startup.

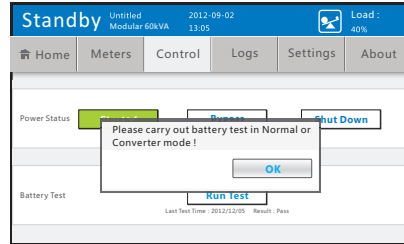

8.5 Logs

① Click the “Logs” icon on the Home menu to enter the Logs interface.

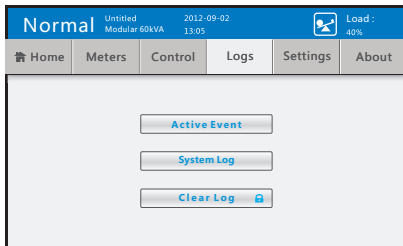

② Click the “Clear Log” and type the service password to enter the clear logs interface.

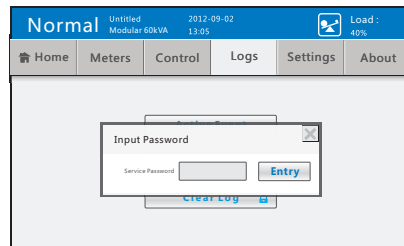

③ Click the “Active Event” to enter the Active event interface. Please refer to the following list for details.

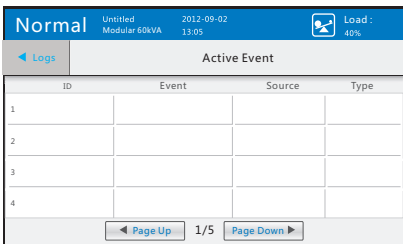

Item	Description
Event ID	Event ID number. Displayed from 0 to 65535
Event name	Details for this event
Event type	Status, Commands, Reminder and Alarm
Source	Module where event occurs

④ Click “System log” and type the service password to enter the System logs interface. Please refer to the following list for details.

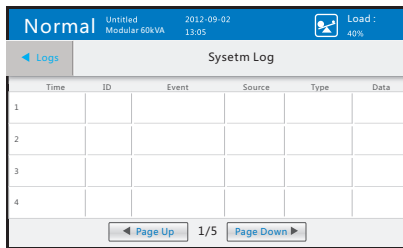

Item	Description
Time	Occurred time in the form of YYYY/MM./DD hh: mm: ss: xxx; xxx is millisecond.
Event ID	Event ID number. Displayed from 0 to 65535
Event name	Details of this event
Event type	Status, Commands, Reminder and Alarm.
Source	Module where event occurs, including CSB and UPM1~UPM10.
Data	The recorded data. Displayed from 0 to 65535

EN

8.6 Setting

① Click the “Settings” icon on the Home menu to enter the Setting interface. The configuration items are intended for customers, while the service items are for the customer service and maintenance personnel.

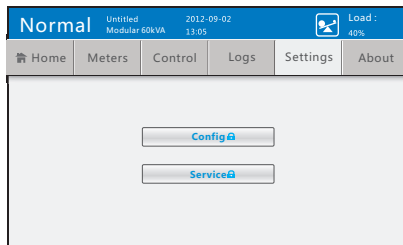

② Click “Config” and type the correct password to enter the Configuration interface.

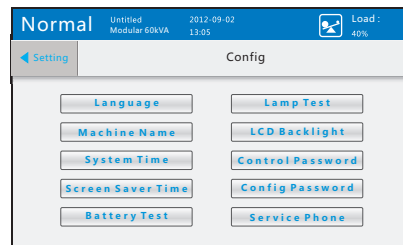

③ Click “Service” and type the correct password to enter the Service interface.



8.6.1 Configuration

① Enter the “Language” interface. The Current language button is in blue and other in off-white.

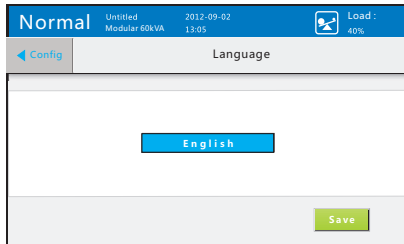

② Enter the “Machine Name” interface. Users set the machine name, which is not more than 14 characters.

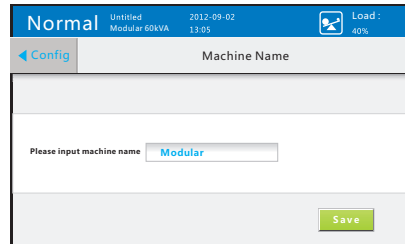

③ Enter the “System Time” interface to set the system time.

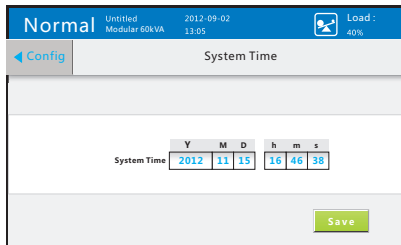

④ Enter the “Battery Test” interface to set the time for battery test. The range is to be set between 0 and 9000s. The default self-test time is 10s.

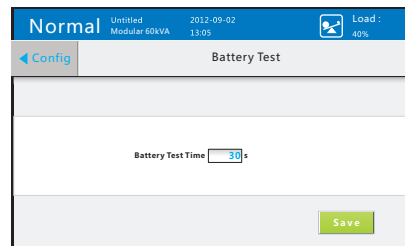

⑤ Enter the “Screen Saver Time” interface to set the Screensaver time. The range is to be set between 10 and 60min.

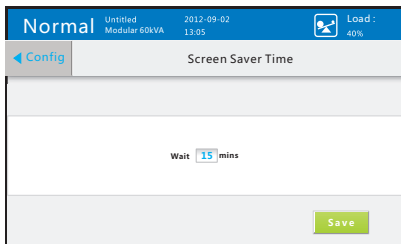

⑥ Enter the “Lamp Test” interface to do the light test.

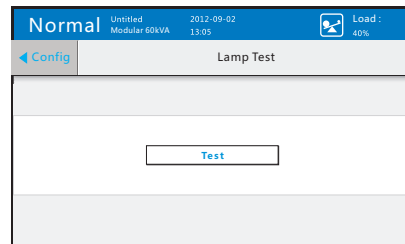

EN

⑦ Enter the “LCD Backlight” interface to set the backlight brightness. The range is to be set between 1% and 100%.

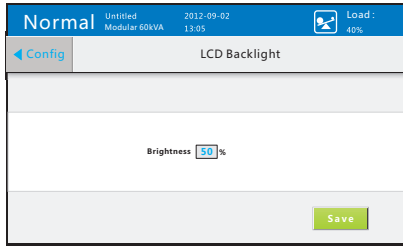

⑧ Enter the “Control Password” interface to set the control password to be enabled or disabled and the password change function.

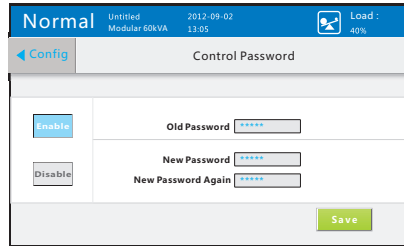

EN

⑨ Enter the “Config Password” interface to set the configuration password to be enabled or disabled and the password change function.

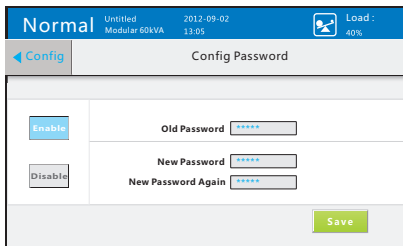

⑩ Enter the “Service Phone” interface to set the telephone number for customer service, which should be not more than 13 characters.

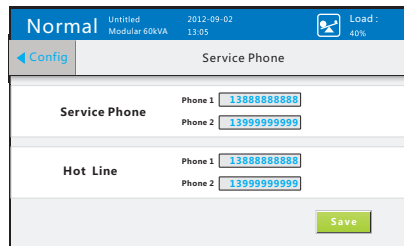

8.6.2 Service

① Enter the “Battery” interface to set the battery configuration, charge and discharge.

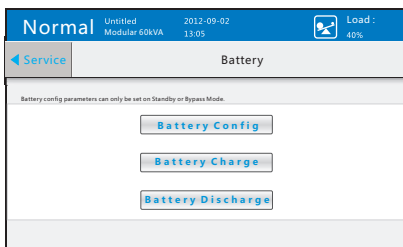

② Enter the “Battery Config” interface to set the battery configuration.

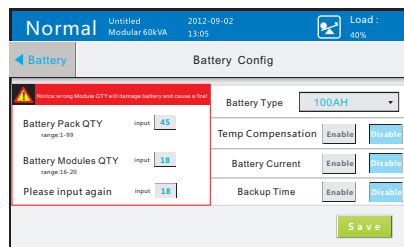

③ Enter the “Output” interface to set the output voltage and frequency for the system.

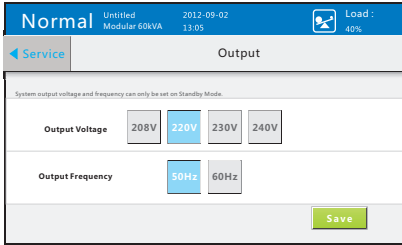

④ Enter the “Bypass” interface to set the upper and lower limit voltage.

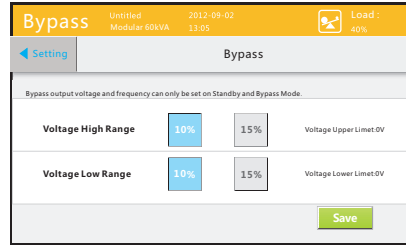

⑤ Enter the “System Mode” interface to set the system mode.

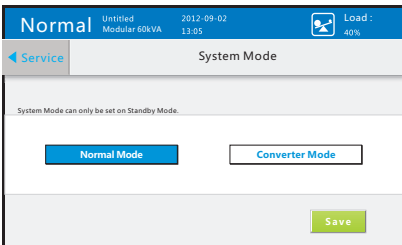

⑥ Enter the “Minislot Baudrate” interface to set the baud rate for the three slots.



⑦ Enter the “Service Reminder” interface to set the over-warranty reminder and maintenance reminder.

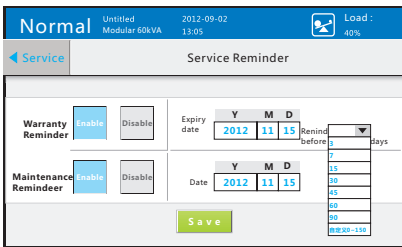

⑧ Enter the “Installed Time” interface to set the installation time.

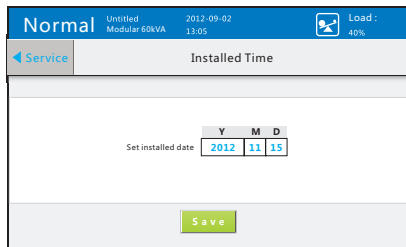

EN

⑨ Enter the “Reset Password” interface to reset the passwords and unlock the XCP burning

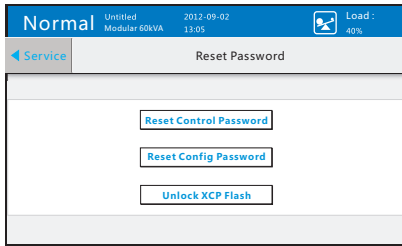

⑩ Enter the “Export Log” interface to export the historical logs to USB.

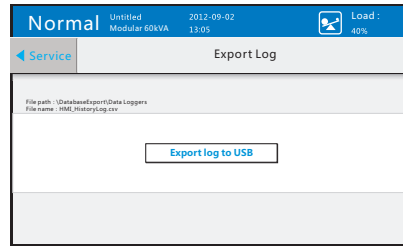

⑪ Enter the “Other Messages” interface to view the information such as BUS voltage.

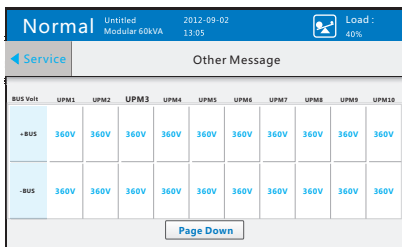

8.7 About

① Click the “About” icon on the Home menu to enter the About interface.

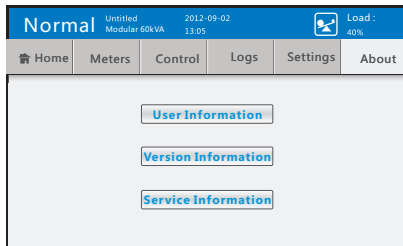

② Click the “User Information” to enter the User information interface.

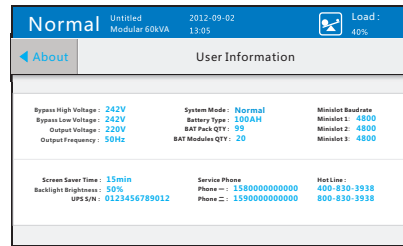

③ Click the “Version Information” to enter the Version information interface.

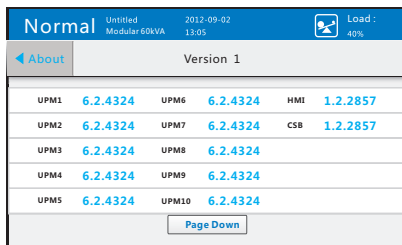

④ Click the “Service Information” to enter the Service information interface.

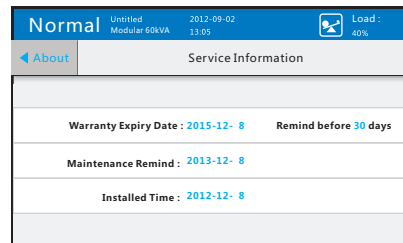

Chapter 9 Maintenance

9.1 Maintenance Notice

1. The UPS and battery maintenance should be performed by trained and qualified technical personnel.
2. For long-term inaction, the battery should be fully charged once every three months in normal temperature environment and once every two months in high temperature environment.
3. The rear part of the UPS consists of two parts, the upper part and the lower part. The maintenance bypass switch and output switch are located in the upper part, and do not operate the two breakers in normal condition, otherwise, it may cause the equipment to be powered off or hazards; the electrified copper bars and module input switches are located in the lower part. The door of the cabinet is locked. Do not attempt to open the door, otherwise, electric shock may occur.

9.2 Service Methods

If the UPS fails and the user cannot make sure it is what causes the UPS fault, please contact the point of service network or the distributor. Do not continue to operate the unit.

9.3 Maintenance Bypass

Note: This function may only be performed when the equipment is powered off due to UPS fault. Do not attempt to operate the UPS until you read through the following operating procedure. Any questions, please consult the service site or the distributor firstly.

1. Operating procedure of transferring to maintenance bypass
 - 1) Open the “maintenance door” of the UPS cabinet (the door located on the rear upper part of the UPS cabinet).
 - 2) Pull the cover plate of the maintenance switch rightward to open it (see Fig 9-1).

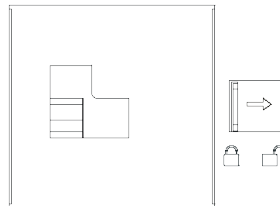

Fig. 9-1

Note: Theoretically, the UPS shall transfer to bypass automatically. Please check the prompts shown on the LCD screen to make sure that the UPS has transferred to bypass. Otherwise, do not perform the next operation.

- 3) Set the maintenance switch to ON position (see Fig. 9-2).
- 4) Turn the UPS output switch to OFF position (see Fig. 9-3).
- 5) Set the input breakers of the UPS modules and the battery switch to OFF position.

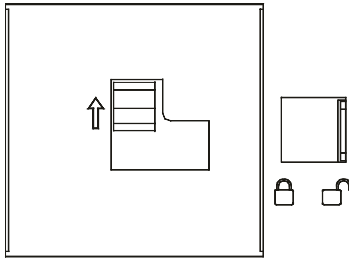

Fig. 9-2

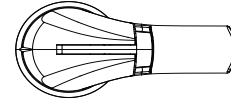
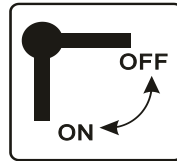
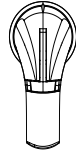
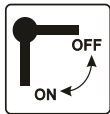

Fig. 9-3

2. Operating procedure of recovering from maintenance bypass

- 1) Set the battery switch and the input breakers of the UPS modules to ON position.
- 2) After all the UPS modules have transferred to the bypass mode, set the output switch of the UPS to ON position (see Fig. 9-4).



Output Switch

Fig. 9-4

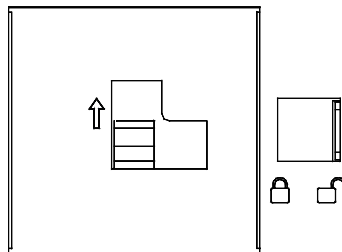

Fig. 9-5

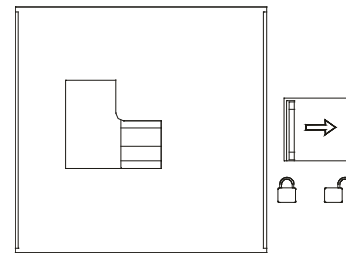

Fig. 9-6

- 3) Set the maintenance switch to OFF position (see Fig. 9-5).
- 4) Pull the cover plate of the maintenance switch leftward to close it (see Fig. 9-6).
- 5) Turning on the UPS through the LCD display and operation panel.

Chapter 10 Communication Interface

10.1 Communication Ports

The UPS series provides Intelligent Slot, EPO and temperature detection port so that the user can monitor the UPS operation status by computer easily (see Fig. 10-1).

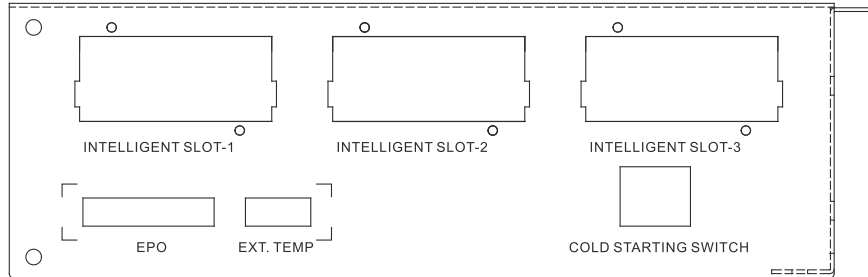

Fig. 10-1

10.2 EPO

The EPO (Emergency Power Off) switch is green and located at the right upper part of the rear panel, which is used to shut down the UPS from local or remote operation in case of any emergency.

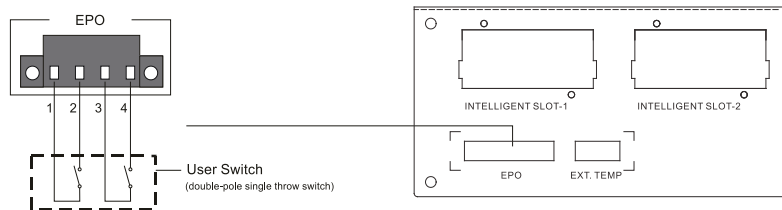

Fig. 10-2

Remark:

Connect 1-2 and 3-4: Emergency Power Off;
Others (including suspending): normal

10.3 Intelligent Slot

This series is equipped with three intelligent slots for maximum three intelligent cards supporting various communication ports such as RS232, USB, RJ45 and dry contacts etc. to realise remote supervising management on UPS.

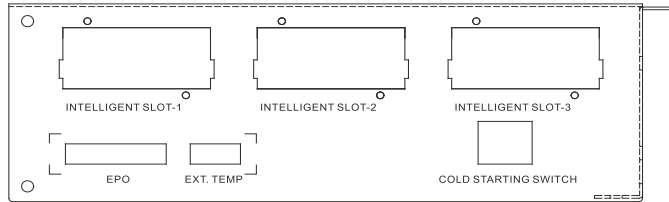

Fig. 10-3

This series is equipped with three intelligent slots, which are available for the following cards:

USB+RS232 Card (Standard): provides standard USB and RS232 communication ports, each kind of port is capable to monitor the UPS operation status.

AS400 Card (Optional): provides dry contact interface for UPS supervising, the contact signals can reflect the UPS operation status so as to realize power source management.

NMC Card (Optional): enables remote supervising management on UPS by accessing Internet.

CMC Card (Optional): operation status on UPS by MODBUS Software remote supervising.

Note:

1. There is no need to shut down the UPS when installing the intelligent cards.
2. Remove the cover plate prior to the installation, and keep it for future use.
3. The USB+RS232 card provides both USB port and RS232 port, users may choose only one of them to connect with the PC.
4. Please refer to relevant information for the application of the WINPOWER software, USB+RS232 card, AS400 card, NMC card and CMC card.
5. WinPower download

With this software, users can monitor and control UPS on the same LAN no matter how far from the UPSs.

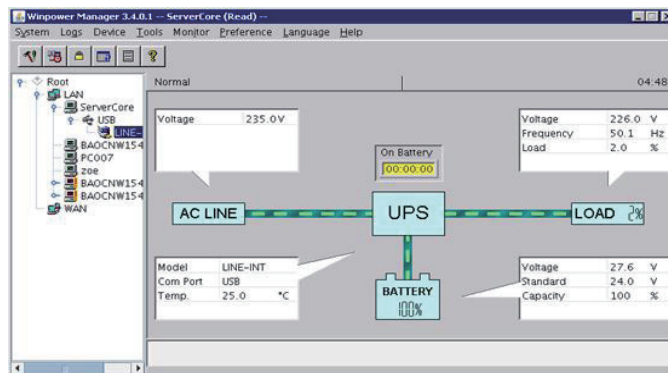

Fig. 10-4

- (1). Go to the website:
<http://www.powerwalker.com/winpower.html>
- (2). Choose the operation system you need and follow the instruction described on the website to download the software.
- (3). When downloading all required files from the internet, enter the serial No: 511C1-01220-0100-478DF2A to install the software.

When your computer restarts, the WinPower software will appear as a green plug icon located in the system tray.

10.4 Battery Temperature Detection Port

Since the battery is sensitive to temperature, the temperature sensor connected to the battery temperature detection port is capable to detect any change of the battery temperature, Charging voltage can be automatically adjusted by UPM according to the temperature to avoid overcharge at high temperature or undercharge at low temperature and thus prolong the battery lifetime. There are two kinds of temperature sensor with different lengths: 5-meter and 2-meter; and users may purchase it from the distributor.

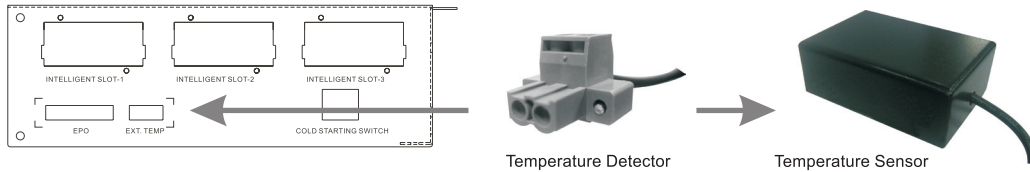

Fig. 10-5

Chapter 11 Troubleshooting

Should the UPS fails during the first time installation or use, which may be caused by improper use. Please check if the installation, wire connection or application is done properly. If yes, then contact the customer service center and provide the following information:

1. MODEL and SERIAL NO of the UPS (on the rear panel of the unit or search them through LCD screen).
2. Information shown on the LCD screen and the LED status of the unit when the fault occurs.

Since there are some installation and operation limitations for the UPS, please pay special attention to the “Note” part in this manual. Please refer to the troubleshootings listed below for common problems treatment.

EN

11.1 Common problems on LCD display

Problem 1: the communication interface not run normally

Possible cause: the communication module is not fully engaged

Solution: draw out the communication module and push it into the bay completely again.

11.2 Common problems on UPS module

Problem 1: the slid module not be detected

Possible cause: the UPS module is not fully engaged

Solution: draw out the UPS module and push it into the bay completely again.

Problem 2: the latest added UPS module fails to be turned on

Possible cause: the position lock of the latest added UPS module is in the position of unlocking or the input breaker is in the position of OFF

Solution: set the position lock to the position of locking and set the input breaker in the position of ON

Problem 3: UPS fails to be powered from the utility

Possible cause: the input phase sequence is wrong, or the input voltage or frequency exceeds the specification range

Solution: check whether the utility power (mains) input voltage or frequency is normal; if the phase sequence is reverse, then correct it.

Problem 4: UPS module not be detected by LCD when starting the unit from DC

Possible cause: the power supply will be cut off automatically if there is no turn-on command received by the module within 30 seconds as soon as it builds a power supply, therefore, the problem may arise because the unit is not turned on in time.

Solution: turn on the unit within 30 seconds as soon as the UPS module builds a power supply

Problem 5: the parallel UPS works in bypass mode and fails to transfer to line mode

Possible cause: the cover plate of the maintenance breaker is not in the position of locking

Solution: set the cover plate of the maintenance breaker to the position of locking

Problem 6: during parallel operation, a blue LED indicator of a module flashes and the LCD display of the module flashes.

Possible cause: module internal fault

Solution: follow the procedure of removing a module online to draw out the module and slide into a new module, then follow the procedure of adding a module online to start the module.

11.3 Common Problems on Battery and Charger

Problem 1: no charging voltage and charging current in line mode

Possible cause: battery is detected to be disconnected when starting the unit and the charger is shut down

Solution: The charger will start up automatically after the the battery is detected.

Problem 2: the battery self-test fails although the battery exists.

Possible cause: the battery breaker is not in the position of ON or the battery is damaged.

Solution: check the battery breaker. Replace the battery if it is damaged.

Chapter 12 Product Specifications

12.1 Electrical Specification

12.1.1 Input Characteristics

Item	Specification
Wiring	3 Phase+ Neutral +Ground
Nominal Voltage	380/400/415 VAC
Nominal Voltage Range	304-520 VAC
Turn on Voltage Range	214-520 VAC
Line Voltage Low Loss/Comeback	(214±10)/(234±10)VAC, Load≤40%
	(214±10)/(268±10)VAC, 40% < Load ≤ 50%
	(242±10)/(268±10)VAC, 50% < Load ≤ 60%
	(242±10)/(303±10)VAC, 60% < Load ≤ 70%
	(298±10)/(323±10)VAC, Load > 70%
Line Voltage High Loss/Comeback	(520±10)/(495±10)VAC, 0% ≤ Load <110%
Bypass Voltage Low Loss/Comeback	Nominal output voltage*(1-n%) n=10,15, default 15
	Low loss voltage + 10.0 VAC, more than 10 seconds delay
Bypass Voltage High Loss/ Comeback	Nominal output voltage*(1+n%) n=10,15, default 15
	High loss voltage - 20.0 VAC, more than 10 seconds delay
Nominal Frequency	50/60Hz auto selection, default 50 Hz
Line Frequency Loss/Comeback	(40/40.5±0.05) Hz
	(70/69.5±0.05) Hz
Bypass Frequency Loss/comeback (50Hz)	(46/46.5±0.05) Hz
	(54/53.5±0.05) Hz
Bypass Frequency Loss/Comeback (60Hz)	(56/56.5±0.05) Hz
	(64/63.5±0.05) Hz
Input Power Factor	≥ 0.99 @ 100% RCD load
Input THDi	< 5% @ 100% RCD load
Generator size	≥20kVA * N, N is Power Module Qty

12.1.2 Output Characteristics

Item	Specification
Wiring	3 Phase+ Neutral +Ground
Nominal Voltage	380/400/415 Vac, default 400 Vac
Voltage Regulation	0%~100%~0% R load: $\pm 1\%$
Voltage Unbalancing	$\leq 3\%$
THDv	100% R load: $< 2\%$
	100% RCD load: $< 4\%$
Nominal frequency	50/60 Hz, Auto detection based on input voltage
Frequency range	Normal mode: 50 ± 4 Hz / 60 ± 4 Hz
	Bypass mode: 50 ± 4 Hz / 60 ± 4 Hz
	Battery/frequency converter mode: (50 ± 0.05)Hz / (60 ± 0.05)Hz
Transient Response	0%~100%~0% R load: $< 10\%$
Efficiency	$> 93\%$ at full load
Overload Capability (Normal mode)	10 minutes minimum, then transfer to bypass and alarm @ 110% $<$ Load $\leq 130\%$
Overload Capability (Battery mode)	10 minutes minimum, then turn off output and alarm @ 110% $<$ Load $\leq 130\%$

12.1.3 Battery and Charger Characteristics

Item	Specification
Wiring	Positive + Neutral + Negative
Nominal Voltage	$\pm K * 12$ VDC K is from 16 to 20
Under Voltage Protection	$\pm 10.2 * K$ VDC
Over Voltage Protection	$\pm 15 * K$ VDC
Charging	Typical Charging Current: $\pm N * 3.5$ A
	Constant Voltage: $\pm 14.3 * K$ VDC
	Floating Voltage: $\pm 13.5 * K$ VDC
Temperature Compensation	-3mV/°C *cell, 2.25 VDC/Cell @25°C

12.1.4 Paralleling

Item	Specification
N + X Redundancy	Yes
Hot Swap	Yes
Power Module Capacity	15 kVA/13.5 kW
Paralleling Power Module QTY	Up to 10

12.2 Noise

< 62 dB (Buzzer is not included).

EN

12.3 Environment

Item	Specification
Operating Temperature	0°C ~ 40°C
Storage Temperature	-25°C ~ 55°C
Operating Humidity	20 % ~ 90 % Non-condensing
Storage Humidity	5% ~ 95 % Non-condensing
Operating Altitude	Less than 1000 m

12.4 Dimensions and net weights

Part Name	Dimension W×D×H (mm)	Net Weight (kg)
90kVA UPS with upper wire connection	608×1000×2050	230
90kVA UPS with lower wire connection	608×1000×2050	230
120kVA UPS with upper wire connection	608×1000×2050	265
120kVA UPS with lower wire connection	608×1000×2050	265
150kVA UPS with lower wire connection	608×1000×2050	275
PDU	483×194×131	9
UPS module	440×707×131	35

Appendix 1: The reference table of LED indicators

No.	Working condition	LED Display				BUZZER
		Normal	Battery	Bypass	Fault	
1	Normal Mode / Converter Mode					
	No Alarm	●				
	Alarm	●			★	Beep every 4 seconds
2	Battery Mode					
	No Alarm	●	●			
	Alarm	●	●		★	Beep every 4 second
3	Battery Test					
	No Alarm	●	●			
	Alarm	●	●		★	Beep every 4 second
4	Bypass Mode / Maintenance bypass					
	No Alarm			●		
	Alarm			●	★	Beep every 4 seconds
5	Fault Mode					
	Bypass Output			●	★	Beep every 4 seconds
	No Output				★	Beep every 4 seconds

Should any display or warning message excluded in the above table be found, please contact the distributors or call the service hot line for advice.

● _LED indicator lighting

★ _LED indicator flashing

Note:

1. The event includes "NOTICE" and "ALARM". Only "ALARM" event will trigger Fault LED flashing and BUZZER.

2. Buzzer stops beeping and fault LED stops flashing once enters to "Logs"- "Active Event" screen.

Appendix 2: Battery configuration

The least number of the battery pack: the batteries with different capacity have different charging and discharging threshold. To maintain the battery's service life, please determine the number of the battery packs according to users' requirement and the following information.

The battery configuration table: the blank columns in the table indicate configuration prohibition and the filled columns indicate the permitted number of the battery packs.

1. 24Ah battery configuration table:

Battery Pack \ Power	24Ah*1	24Ah*2	24Ah*3	24Ah*4	24Ah*5	24Ah*6	24Ah*7	24Ah*8
15kVA								
30kVA								
45kVA								
60kVA								
75kVA								
90kVA								
105kVA								
120kVA								
135kVA								
150kVA								

2. 38Ah battery configuration table:

Battery Pack \ Power	38Ah*1	38Ah*2	38Ah*3	38Ah*4	38Ah*5	38Ah*6	38Ah*7	38Ah*8
15kVA								
30kVA								
45kVA								
60kVA								
75kVA								
90kVA								
105kVA								
120kVA								
135kVA								
150kVA								

3. 65Ah battery configuration table:

Battery Pack \ Power	65Ah*1	65Ah*2	65Ah*3	65Ah*4	65Ah*5	65Ah*6	65Ah*7	65Ah*8
15kVA								
30kVA								
45kVA								
60kVA								
75kVA								
90kVA								
105kVA								
120kVA								
135kVA								
150kVA								

4. 75Ah battery configuration table:

Battery Pack \ Power	75Ah*1	75Ah*2	75Ah*3	75Ah*4	75Ah*5	75Ah*6	75Ah*7	75Ah*8
15kVA								
30kVA								
45kVA								
60kVA								
75kVA								
90kVA								
105kVA								
120kVA								
135kVA								
150kVA								

EN

5. 100Ah battery configuration table:

Battery Pack \ Power	100Ah*1	100Ah*2	100Ah*3	100Ah*4	100Ah*5	100Ah*6	100Ah*7	100Ah*8
15kVA								
30kVA								
45kVA								
60kVA								
75kVA								
90kVA								
105kVA								
120kVA								
135kVA								
150kVA								

EN

6. 120Ah battery configuration table:

Battery Pack \ Power	120Ah*1	120Ah*2	120Ah*3	120Ah*4	120Ah*5	120Ah*6	120Ah*7	120Ah*8
15kVA								
30kVA								
45kVA								
60kVA								
75kVA								
90kVA								
105kVA								
120kVA								
135kVA								
150kVA								

